

Panasonic®

Owner's Manual Blu-ray Disc™ Player

Model No. DMP-BD75



Dear customer

Thank you for purchasing this product.

For optimum performance and safety, please read these instructions carefully.

Before connecting, operating or adjusting this product, please read the instructions completely.

Please keep this manual for future reference.

If you have any questions contact
U.S.A. and Puerto Rico : 1-800-211-PANA(7262)
Canada : 1-800-561-5505

P

PC

VQT3A92

IMPORTANT SAFETY INSTRUCTIONS

Read these operating instructions carefully before using the unit. Follow the safety instructions on the unit and the applicable safety instructions listed below. Keep these operating instructions handy for future reference.

- 1 Read these instructions.
- 2 Keep these instructions.
- 3 Heed all warnings.
- 4 Follow all instructions.
- 5 Do not use this apparatus near water.
- 6 Clean only with dry cloth.
- 7 Do not block any ventilation openings. Install in accordance with the manufacturer's instructions.
- 8 Do not install near any heat sources such as radiators, heat registers, stoves, or other apparatus (including amplifiers) that produce heat.
- 9 Do not defeat the safety purpose of the polarized or grounding-type plug. A polarized plug has two blades with one wider than the other. A grounding-type plug has two blades and a third grounding prong. The wide blade or the third prong are provided for your safety. If the provided plug does not fit into your outlet, consult an electrician for replacement of the obsolete outlet.
- 10 Protect the power cord from being walked on or pinched particularly at plugs, convenience receptacles, and the point where they exit from the apparatus.
- 11 Only use attachments/accessories specified by the manufacturer.
- 12 Use only with the cart, stand, tripod, bracket, or table specified by the manufacturer, or sold with the apparatus. When a cart is used, use caution when moving the cart/apparatus combination to avoid injury from tip-over.
- 13 Unplug this apparatus during lightning storms or when unused for long periods of time.
- 14 Refer all servicing to qualified service personnel. Servicing is required when the apparatus has been damaged in any way, such as power-supply cord or plug is damaged, liquid has been spilled or objects have fallen into the apparatus, the apparatus has been exposed to rain or moisture, does not operate normally, or has been dropped.



CAUTION

RISK OF ELECTRIC SHOCK
DO NOT OPEN

CAUTION: TO REDUCE THE RISK OF ELECTRIC SHOCK, DO NOT REMOVE SCREWS. NO USER-SERVICEABLE PARTS INSIDE. REFER SERVICING TO QUALIFIED SERVICE PERSONNEL.



The lightning flash with arrowhead symbol, within an equilateral triangle, is intended to alert the user to the presence of uninsulated "dangerous voltage" within the product's enclosure that may be of sufficient magnitude to constitute a risk of electric shock to persons.



The exclamation point within an equilateral triangle is intended to alert the user to the presence of important operating and maintenance (servicing) instructions in the literature accompanying the appliance.

THE FOLLOWING APPLIES ONLY IN THE U.S.A. FCC Note:

This equipment has been tested and found to comply with the limits for a Class B digital device, pursuant to Part 15 of the FCC Rules. These limits are designed to provide reasonable protection against harmful interference in a residential installation. This equipment generates, uses, and can radiate radio frequency energy and, if not installed and used in accordance with the instructions, may cause harmful interference to radio communications. However, there is no guarantee that interference will not occur in a particular installation. If this equipment does cause harmful interference to radio or television reception, which can be determined by turning the equipment off and on, the user is encouraged to try to correct the interference by one or more of the following measures:

- Reorient or relocate the receiving antenna.
- Increase the separation between the equipment and receiver.
- Connect the equipment into an outlet on a circuit different from that to which the receiver is connected.
- Consult the dealer or an experienced radio/TV technician for help.

FCC Caution: To assure continued compliance, follow the attached installation instructions and use only shielded interface cables when connecting to peripheral devices.

Any changes or modifications not expressly approved by the party responsible for compliance could void the user's authority to operate this equipment.

This device complies with Part 15 of the FCC Rules. Operation is subject to the following two conditions: (1) This device may not cause harmful interference, and (2) this device must accept any interference received, including interference that may cause undesired operation.

Responsible Party:
Panasonic Corporation of North America
One Panasonic Way, Secaucus, NJ 07094
Support Contact:
Panasonic Consumer Electronics Company
Telephone No.: 1-800-211-PANA (7262)

WARNING

Unit

- To reduce the risk of fire, electric shock or product damage,
- Do not expose this unit to rain, moisture, dripping or splashing.
 - Do not place objects filled with liquids, such as vases, on this unit.
 - Use only the recommended accessories.
 - Do not remove covers.
 - Do not repair this unit by yourself. Refer servicing to qualified service personnel.

CAUTION

Unit

- This unit utilizes a laser. Use of controls or adjustments or performance of procedures other than those specified herein may result in hazardous radiation exposure.
- Do not place sources of naked flames, such as lighted candles, on this unit.

Placement

- To reduce the risk of fire, electric shock or product damage,
- Do not install or place this unit in a bookcase, built-in cabinet or in another confined space. Ensure this unit is well ventilated.
 - Do not obstruct this unit's ventilation openings with newspapers, tablecloths, curtains, and similar items.

CAUTION	VISIBLE AND INVISIBLE LASER RADIATION WHEN OPEN, DO NOT STARE INTO BEAM. FDA 21 CFR/Class II (IIR)
CAUTION	CLASS 1M VISIBLE AND INVISIBLE LASER RADIATION WHEN OPEN. DO NOT VIEW DIRECTLY WITH OPTICAL INSTRUMENTS. FCC/CLASS II
ATTENTION	RAYONNEMENT LASER VISIBLE ET INVISIBLE. CLASSE 1M, EN CAS D'OUVERTURE. NE PAS REGARDER DIRECTEMENT À L'ŒIL DES INSTRUMENTS D'OPTIQUE.
FORSIGTIG	SYNLIGO OG USYNLIGO LASERSTRÅLING NÅR DENNA DEL ÄR ÖPPNAD, BETRÄKTA EJ STRÅLEN DIREKT GENOM OPTISKT INSTRUMENT.
VARO	AVATTAESSA OLET ALTTIINA LUOKAN 1M NÄKYVÄÄ JA NÄKYMÄTONTA LASERSÄTELYÄ. ÄLÄ KATSO OPTISELLA LAITTEELLA SUORAAN SÄTEESEEN.
VARNING	KLASS 1M SYNLIGO OCH USYNLIGO LASERSTRÅLING NÅR DENNA DEL ÄR ÖPPNAD, BETRÄKTA EJ STRÅLEN DIREKT GENOM OPTISKT INSTRUMENT.
VORSICHT	SICHTBARE UND UNSICHTBARE LASERSTRÄHLUNG KLASSE 1M, WENN ABDECKUNG GEÖFFNET. NICHT DIREKT MIT OPTISCHEN INSTRUMENTEN BETRACHTEN.
注意	— 打开时有可见及不可见激光辐射。避免光束照射。
注意	— ここを開くと可視及び不可視レーザー光が出ます。ビームを見たり、触れたりしないでください。 VQL1V70

(Inside of product)

Table of contents

Getting started

IMPORTANT SAFETY	
INSTRUCTIONS	2
Accessories	4
Unit and media care	4
Control reference guide	5
Playable discs/USB devices	6

Connections & Settings

STEP 1 : Connecting to a TV	8
STEP 2 : Connecting to an amplifier/ receiver	9
STEP 3 : Connecting to a broadband network	9
STEP 4 : Connecting to an AC power source	10
STEP 5 : Settings	10

Playback

Inserting or removing media	13
HOME menu	13
Playing video contents	14
Playing still pictures	17
Playing music	18
Enjoying Network Service	18
Playing back contents on the DLNA server (DLNA)	19
Linked operations with the TV (VIERA Link™ “HDAVI Control™”).	20

Settings

Playback menu	21
Setup menu	22

Reference

Troubleshooting guide	26
Messages	28
Supplemental information	29
Specifications	30
Limited Warranty (ONLY FOR U.S.A. AND PUERTO RICO)	33
Limited Warranty (Only for CANADA)	34
Referencia rápida en español (Spanish Quick Reference)	35
Index	Back cover

About descriptions in this Owner's Manual

- Instructions for operations are generally described using the remote control.

About Firmware updates (⇒ 12)

Accessories

Check the supplied accessories before using this unit.

- 1 **Remote control**
(N2QAYB000575)
- 2 **Batteries for remote control**
 - 1 **AC power supply cord**
(K2CB2CB00022)

For Canada

The enclosed Canadian French label sheet corresponds to the English display on the front and back side of the unit.



- Product numbers provided in this Owner's Manual correct as of December 2010. These may be subject to change.
- Do not use AC power supply cord with other equipment.
- **For U.S.A. and Puerto Rico** : To order accessories, refer to "Accessory Purchases (United States and Puerto Rico)" on page 33.
- **For Canada** : To order accessories, call the dealer from whom you have made your purchase.

Using the remote control

Insert so the poles (+ and -) match those in the remote control.

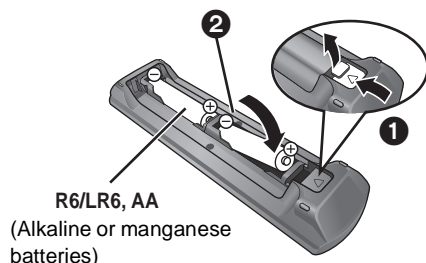

Point it at remote control signal sensor on this unit. (⇒ 5)



Mishandling of batteries can cause electrolyte leakage which can damage items the fluid contacts and may cause a fire.

- Do not mix old and new batteries or different types at the same time.
- Do not heat or expose to flame.
- Do not leave the battery(ies) in a car exposed to direct sunlight for a long period of time with doors and windows closed.
- Do not take apart or short circuit.
- Do not attempt to recharge alkaline or manganese batteries.
- Do not use batteries if the covering has been peeled off.

Remove batteries if the remote control is not going to be used for a long period of time. Store in a cool, dark place.

CAUTION

- Danger of explosion if battery is incorrectly replaced. Replace only with the type recommended by the manufacturer.
- When disposing the batteries, please contact your local authorities or dealer and ask for the correct method of disposal.

Unit and media care

■ Clean this unit with a soft, dry cloth

- Never use alcohol, paint thinner or benzene to clean this unit.
- Before using chemically treated cloth, carefully read the instructions that came with the cloth.

■ Clean the lens

- Use the lens cleaner (not supplied) to clean the unit's lens.

■ Clean discs

DO

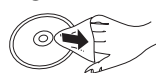

DO NOT



Wipe with a damp cloth and then wipe dry.

■ Disc handling precautions

- Handle discs by the edges to avoid inadvertent scratches or fingerprints on the disc.
- Do not attach labels or stickers to discs.
- Do not use record cleaning sprays, benzene, thinner, static electricity prevention liquids or any other solvent.
- Do not use the following discs:
 - Discs with exposed adhesive from removed stickers or labels (rented discs etc).
 - Discs that are badly warped or cracked.
 - Irregularly shaped discs, such as heart shapes.

■ To dispose or transfer this unit

The unit may keep the user settings information in the unit. If you discard this unit either by disposal or transfer, then follow the procedure to return all the settings to the factory presets to delete the user settings. (⇒ 26, "To return all settings to the factory preset.")

- The operation history may be recorded in the memory of this unit.

Control reference guide

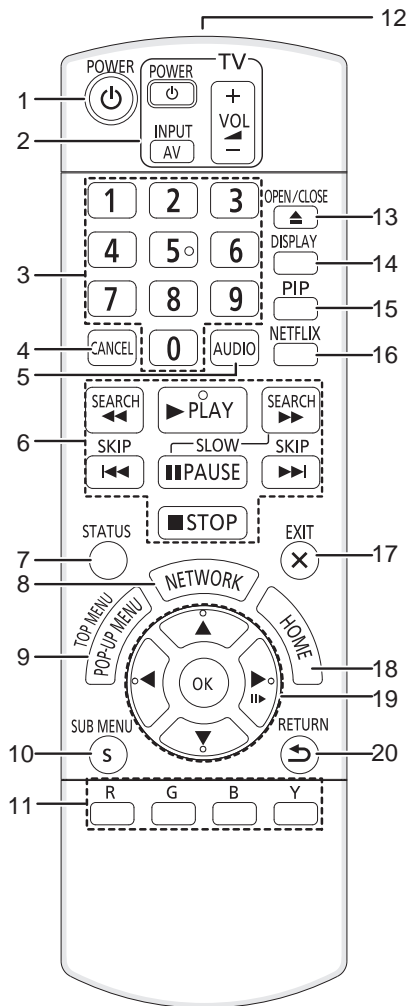

- 1 Turn the unit on and off
 - 2 TV operation buttons
You can operate the Panasonic TV through the unit's remote control. (Depending on the TV these buttons may not work.)
[$\text{\textcircled{I}}$ TV POWER] : Turn the television on and off
[AV] : Switch the input select
[+ - VOL] : Adjust the volume
 - 3 Select title numbers, etc./Enter numbers
 - 4 Cancel
 - 5 Select audio (\Rightarrow 14)
 - 6 Basic playback control buttons (\Rightarrow 14)
 - 7 Show status messages (\Rightarrow 14)
 - 8 Show the selection screen of network features (\Rightarrow 18)
 - 9 Show Pop-up menu/Top menu/Direct Navigator (\Rightarrow 14)
 - 10 Show sub menu (\Rightarrow 15)
 - 11 These buttons are used when;
 - Operating a BD-Video disc that includes Java™ applications (BD-J).
 - Operating contents of Network Service. (\Rightarrow 18)
 - 12 Transmit the remote control signal
 - 13 Open or close the disc tray (\Rightarrow 13)
- CAUTION**
Do not place objects in front of the unit. The disc tray may collide with objects when it is opened, and this may cause malfunction.
- 14 Show Playback menu (\Rightarrow 21)
 - 15 Switch on/off Secondary Video (Picture-in-picture) (\Rightarrow 16)
 - 16 Show NETFLIX screen
 - 17 Exit the menu screen
 - 18 Show HOME menu (\Rightarrow 13)
 - 19 Selection/OK, Frame-by-frame (\Rightarrow 14)
 - 20 Return to previous screen

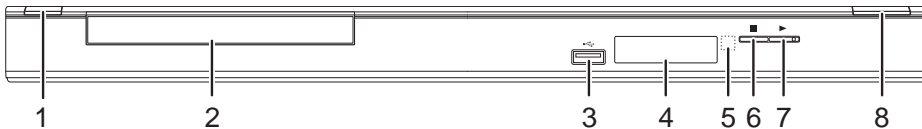







- 1 **POWER button (POWER $\text{\textcircled{I}}$)** (\Rightarrow 10)
Press to switch the unit from on to standby mode or vice versa. In standby mode, the unit is still consuming a small amount of power.
- 2 Disc tray (\Rightarrow 13)
- 3 USB port (\Rightarrow 13)
- 4 Display (\Rightarrow 29)

- 5 Remote control signal sensor
Distance: Within approx. 7 m (23 feet)
Angle: Approx. 20° up and down, 30° left and right
- 6 Stop (\Rightarrow 14)
- 7 Start play (\Rightarrow 14)
- 8 Open or close the disc tray (\Rightarrow 13)

Rear panel terminals (\Rightarrow 8–10)

Playable discs/USB devices

Type	Logo examples	Type detail	Playable contents (⇒ 30)
BD		BD-Video	Video
		BD-RE	Video JPEG
		BD-R	Video MKV
DVD		DVD-Video	Video
		DVD-R	Video AVCHD MKV MP3 JPEG
		DVD-R DL	Video AVCHD
		DVD-RW	Video AVCHD
	—	+R/+RW/+R DL	
CD		Music CD	Music [CD-DA]
	—	CD-R CD-RW	MKV Music [CD-DA] MP3 JPEG
USB	—	USB devices (up to 2 TB)	MKV MP3 JPEG

■ Discs that cannot be played in this unit

Any other disc that is not specifically supported or previously described.

- DVD-RAM
- Super Audio CD
- Photo CD
- DVD-Audio
- WMA discs
- DivX discs
- PAL discs
- HD DVD
- BD-Video discs recorded at a rate of 50 fields/sec

■ Region management information

BD-Video

This unit plays BD-Video marked with labels containing the region code "A".

Example:



DVD-Video

This unit plays DVD-Video marked with labels containing the region number "1" or "ALL".

Example:



■ Finalize

DVD-R/RW/R DL, +R/+RW/+R DL and CD-R/RW recorded by a recorder, etc. needs to be finalized by the recorder to play on this unit. Please refer to the recorder's instructions.

■ BD-Video

- This unit supports high bit rate audio (Dolby Digital Plus, Dolby TrueHD, DTS-HD High Resolution Audio and DTS-HD Master Audio) adopted in BD-Video.
 - If "Dolby D/Dolby D +/Dolby TrueHD" is set to "PCM", the maximum possible number of Dolby sound is 2ch PCM. (⇒ 23)

■ Music CD

- Operation and sound quality of CDs that do not conform to CD-DA specifications (copy control CDs, etc.) cannot be guaranteed.
- The digital audio content side of a DualDisc does not meet the technical specifications of the Compact Disc Digital Audio (CD-DA) format so playback may not be possible.

■ USB device

- This unit does not guarantee connection with all USB devices.
- This unit does not support USB device charging.
- FAT12, FAT16 and FAT32 file systems are supported.
- This unit supports USB 2.0 High Speed.
- This unit supports an HDD formatted in FAT32. If the HDD is not recognized the power to the HDD may not be supplied. Supply power from an external source.



- It may not be possible to play the above media in some cases due to the type of media, the condition of the recording, the recording method and how the files were created.
- The producers of the disc can control how discs are played, so you may not always be able to control play as described in this Owner's Manual. Read the disc's instructions carefully.

STEP 1 : Connecting to a TV

- Do not place the unit on amplifiers/receivers or equipment that may become hot. The heat can damage the unit.
- Before making any connections we suggest you temporarily disconnect all the units from AC power.
- Do not connect video signals through a video recorder. Due to copy guard protection the picture may not be displayed properly.
- Please use High Speed HDMI Cables that have the HDMI logo (as shown on the back cover). It is recommended that you use Panasonic's HDMI cable. When outputting 1080p signal, please use HDMI cables 5.0 meters (16.4 ft.) or less.
Recommended part number (High Speed HDMI Cable): RP-CDHS15 (1.5 m/4.9 ft.), RP-CDHS30 (3.0 m/9.8 ft.), RP-CDHS50 (5.0 m/16.4 ft.), etc.

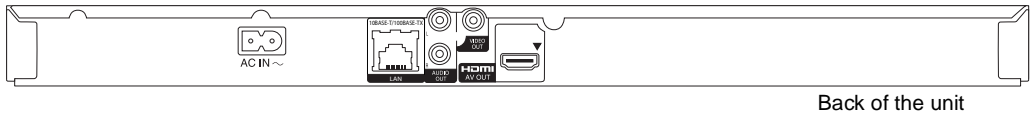

■ Via an HDMI AV OUT terminal (High quality)

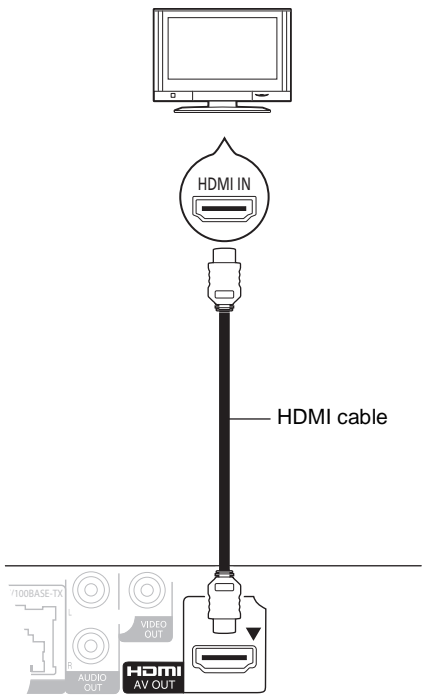

- Set "HDMI Audio Output" to "On" (⇒ 24).
- The HDMI connection supports VIERA Link "HDAVI Control" (⇒ 20).

■ Via a VIDEO OUT terminal (Standard quality)

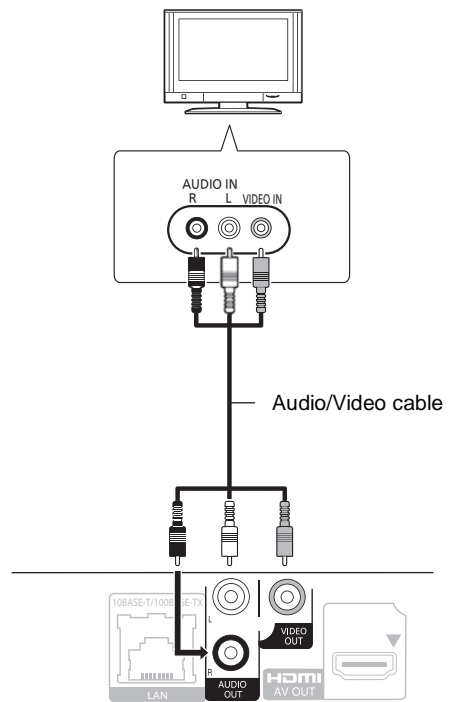

- Connect terminals of the same color.

STEP 2 : Connecting to an amplifier/receiver

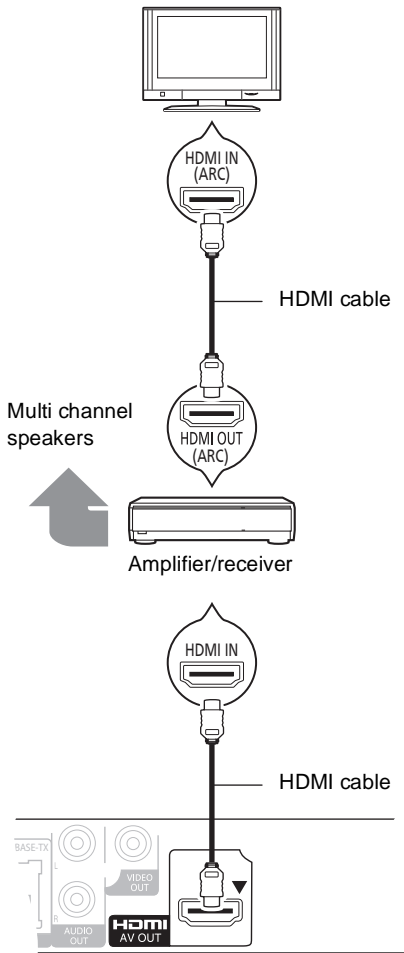

- Set "HDMI Audio Output" to "On" (⇒ 24).
- Set "Digital Audio Output" depending on the connected amplifier/receiver (⇒ 23).
- The HDMI connection supports VIERA Link "HDAVI Control" (⇒ 20).
- When using the TV or amplifier/receiver that does not have the indication of "(ARC)" (non-ARC-compatible) on the HDMI terminal, in order to enjoy TV's sound by amplifier it is also required to connect the amplifier/receiver and TV using an optical digital cable.

STEP 3 : Connecting to a broadband network

The following services can be used when this unit is connected to broadband.

- Firmware can be updated (⇒ 12)
- You can enjoy BD-Live (⇒ 16)
- You can enjoy Network Service (⇒ 18)
- DLNA feature (⇒ 19)

For details about connection method, refer to the instructions supplied with the connected equipment.

■ LAN cable connection

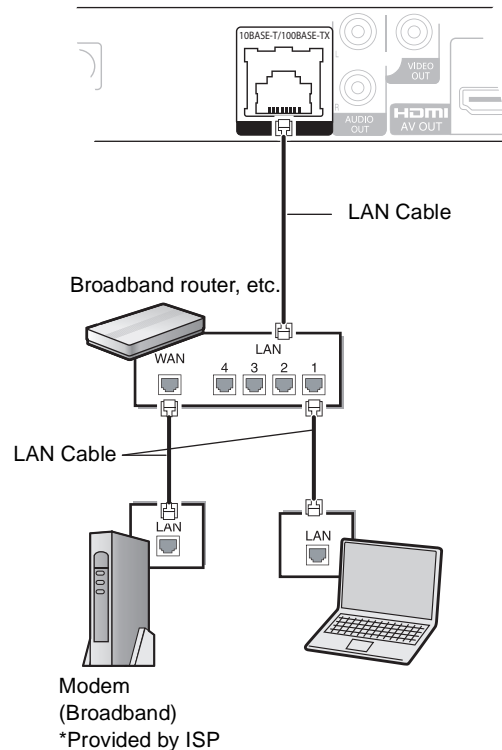

- Use category 5 or above straight LAN cables (STP) when connecting to peripheral devices.
- Inserting any cable other than a LAN cable in the LAN terminal can damage the unit.

STEP 4 : Connecting to an AC power source

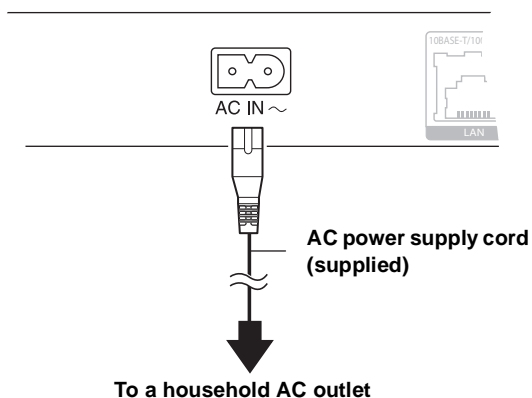

- This unit consumes a small amount of AC power (“Quick Start”: “Off”, approx. 0.1 W) even when turned off. In the interest of power conservation, if you will not be using this unit for an extended period of time, it can be disconnected.

Install this unit so that the power cord can be unplugged from the socket outlet immediately if any problem occurs.

STEP 5 : Settings

Easy Setting

After connecting your new player for the 1st time and pressing the power button, a screen for the basic settings will appear.

Preparation

Turn on the television and select the appropriate video input on the television.

1 Press [POWER].

Setup screen appears.

2 Follow the on-screen instructions and make the settings with [▲, ▼] and press [OK].

After completing “Easy Setting”, you can perform “Network Easy Setting”.



- You can perform this setup anytime by selecting “Easy Setting” in the Setup menu. (⇒ 25)

Network Easy Setting

The configuration of your network is about to begin.

Follow the on-screen instructions and make the settings with [▲, ▼, ◀, ▶] and press [OK].

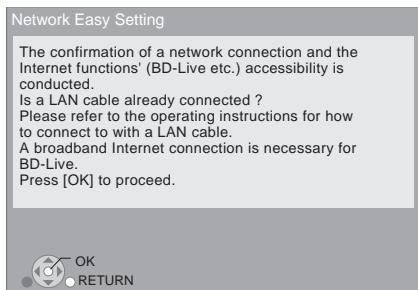

When you experience problems with settings

Network Easy Setting (Home Network Connection Check)

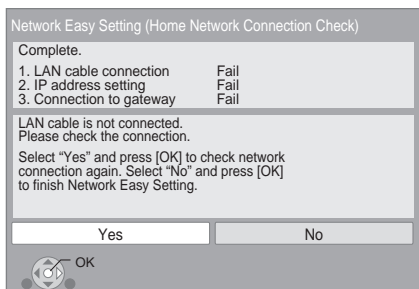

Display		Check the following
1. LAN cable connection	Fail	● Connection of the LAN cables (⇒ 9)
2. IP address setting	Fail	
3. Connection to gateway	Fail	
1. LAN cable connection	Pass	● Connection and settings of the hub and router
2. IP address setting	Fail	
3. Connection to gateway	Fail	
1. LAN cable connection	Pass	● Settings of "IP Address/DNS Settings" (⇒ 24)
2. IP address setting	Pass or Home network available	
3. Connection to gateway	Fail	

Network Easy Setting (Internet Connection Check)

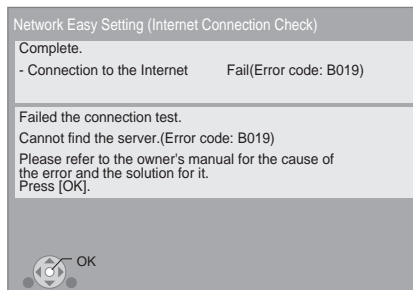

Display	Check the following
Cannot find the server. (Error code: B019)	<ul style="list-style-type: none"> ● "Primary DNS" and "Secondary DNS" settings of "IP Address/DNS Settings" (⇒ 24)
Failed to connect to the server. (Error code: B020)	<ul style="list-style-type: none"> ● The server may be busy or the service may have been suspended. Please wait a few moments, and then try again. ● Settings of "Proxy Server Settings" (⇒ 24) and the router



- Refer to the operating instructions of the hub or router.
- You can perform this setup anytime by selecting "Network Easy Setting" in the Setup menu. (⇒ 24)
- You can redo these settings individually using "Network Settings". (⇒ 24)

Reprogramming the remote control

If you have more than one Panasonic player/recorder and the remote control operates both products at once, you will need to change the remote control code on one product to prevent this occurrence. (⇒ 25, "Remote Control Code")

Firmware updates

Occasionally, Panasonic may release updated firmware for this unit that may add or improve the way a feature operates. These updates are available free of charge.

This unit is capable of checking the firmware automatically when connected to the Internet via a broadband connection. When a new firmware version is available, the following message is displayed.

New firmware is available.
Please update firmware in Setup.

To update the firmware

Press **[HOME]** ⇒ select **“Setup”** ⇒ select **“Player Settings”** ⇒ select **“Others”** ⇒ **[OK]** ⇒ select **“Firmware Update”** ⇒ **[OK]** ⇒ select **“Update Now”**

DO NOT DISCONNECT the unit from the AC power or perform any operation while the update takes place. After the firmware is installed, “FINISH” will be displayed on the unit’s display. Unit will restart and the following screen will be displayed.

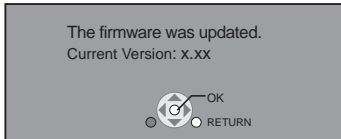

- If downloading on this unit fails or this unit is not connected to the Internet, then you can download the latest firmware from the following website and burn it to a CD-R to update the firmware.
<http://panasonic.jp/support/global/cs/>
(This site is in English only.)
To show the firmware version on this unit. (⇒ 25, “System Information”)
- Downloading will require several minutes. It may take longer or may not work properly depending on the connection environment.
- If you do not want to check for the latest firmware version, set “Automatic Update Check” to “Off”. (⇒ 25)

Inserting or removing media

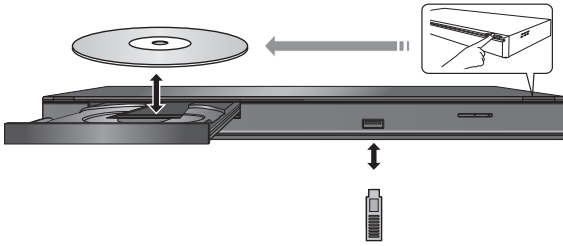

- When inserting a media item, ensure that it is facing the right way up.
- If you connect a Panasonic product with a USB connection cable, the setup screen may be displayed on the connected equipment. For details, refer to the instructions for the connected equipment.

HOME menu

Major functions of this unit can be operated from the HOME menu.

Preparation

Turn on the television and select the appropriate video input on the television.

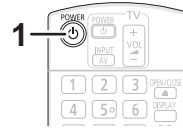

- 1 Press [POWER] to turn on the unit.
- 2 Press [OK] or [▲, ▼, ◀, ▶] to select the item.

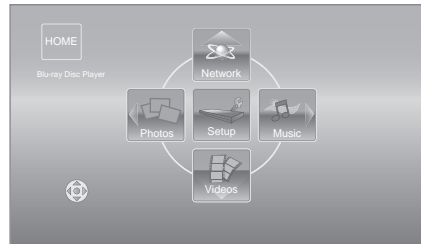

- When a media is inserted, contents selection screen for that media is displayed.
- If there are any other items, repeat this step.
- To return to HOME menu, select "HOME" or press [RETURN] several times.

Videos/ Photos/ Music	Disc	Play back the contents. (⇒ 14, 17, 18) • When multiple contents are recorded, select the types of contents or the title.
	USB	
Network	Internet Content	Displays the home screen of Network Service (⇒ 18)
	DLNA Client	(⇒ 19)
Setup	Player Settings	(⇒ 22)
	USB Management	(⇒ 16)

To show the HOME menu

Press [HOME].



- Items to be displayed may vary with the media.
- Where necessary, set "Mixed Data Disc Option" when using a disc with both data files (MP3, JPEG, MKV) and Video. (⇒ 22)

Playing video contents

BD DVD CD USB

1 Insert the media.

If the menu is displayed, press [▲, ▼, ◀, ▶] to select the item. (⇒ 13)

2 Press [▲, ▼] to select the title and press [OK].

■ To show menus

You can show Top Menu, Direct Navigator or Pop-up Menu. Press [POP-UP MENU/TOP MENU].

- Press [▲, ▼, ◀, ▶] to select the item and press [OK].

■ To show the status messages

While playing, press [STATUS].

The status messages give you information about what is currently being played. Each time you press [STATUS], the display information may change or will disappear from the screen.

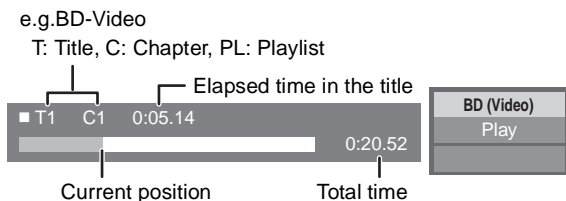

- DISCS CONTINUE TO ROTATE WHILE MENUS ARE DISPLAYED. Press [■STOP] when you have finished playback to protect the unit's motor, your television screen and so on.
- Depending on media and contents, the display may change or may not appear.
- MKV : Successive play is not possible.
- It is not possible to playback AVCHD and MPEG2 video which have been dragged and dropped, copied and pasted to the media.
- To save on electricity, the power is turned off automatically if there is no button operation for about 30 minutes when not playing back (such as when paused, displaying the menu, displaying still pictures, etc.). (Compatible with ENERGY STAR)

Other operations during play

These functions may not work depending on the media and contents.

Stop

Press [■STOP].

The stopped position is memorized.

Resume play function

Press [▶PLAY] to restart from this position.

- The position is cleared if the tray is opened or you press [■STOP] several times to display "StOP" on the unit's display.
- On BD-Video discs including BD-J, the resume play function does not work.

Pause

Press [⏸PAUSE].

- Press [⏸PAUSE] again or [▶PLAY] to restart play.

Search/Slow-motion

Search

While playing, press [SEARCH◀◀] or [SEARCH▶▶].

- Music and MP3: The speed is fixed to a single step.

Slow-motion

While paused, press [SEARCH▶▶].

The speed increases up to 5 steps.

- Press [▶PLAY] to revert to normal playback speed.

Skip

While playing or paused, press [◀◀] or [▶▶].

Skip to the title, chapter or track you want to play.

- Each press increases the number of skips.

Frame-by-frame

While paused, press [▶] (⏪▶).

- Press and hold to change in succession forward.
- Press [▶PLAY] to revert to normal playback speed.

Changing audio

Press [AUDIO].

You can change the audio channel number or soundtrack language, etc.

Useful functions

1 Press [SUB MENU].

2 Select an item, then press [OK].

While Direct Navigator screen is displayed

View Playlists	To play playlists.
View Titles	To select the title.
Select Folder	To switch to another folder.

While playing

Top Menu	To display Top Menu.
Pop-up Menu	To display Pop-up Menu.
Menu	To display Menu.



- Depending on the media and contents, displayed items are different.

■ Displaying subtitle text

You can display subtitle text on the MKV video disc with this unit. The operation might be different or it may not operate properly depending on the way the file was made or the state of this unit (playing, stopped, etc.).

Set “Subtitle” in “Disc” (⇒ 21)



- MKV video files that do not display “Text” do not contain subtitle text.
- If the subtitle text is not displayed correctly, try changing the language settings. (⇒ 22)

Enjoying BD-Live or picture-in-picture in BD-Video

Enjoying BD-Live discs with Internet

BD-Live allows you to enjoy more functions such as subtitles, exclusive images and online games by connecting this unit to the Internet. Since most of the BD-Live compatible discs are played back using the BD-Live function, additional contents are required to be downloaded into the external memory (local storage).

- This unit is using a USB device as a local storage device.
BD-Live function cannot be used when there is no USB device inserted.

1 Perform network connection and settings. (⇒ 9, 11)

2 Insert a USB memory with 1 GB or more free space.

3 Insert the disc.

■ Deleting data on the USB device

If you no longer need data recorded on the USB device, you can delete data with the following operation.

- ① Insert a USB device.
- ② Press [HOME].
- ③ Press [OK] to select "Setup".
- ④ Press [▶] to select "USB Management".
- ⑤ Press [OK].

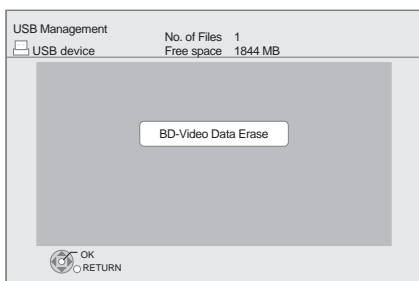

- ⑥ Press [◀, ▶] to select "Yes" and press [OK].
- ⑦ Press [◀, ▶] to select "Start" and press [OK].

Playing picture-in-picture

To turn on/off secondary video
Press [PIP].

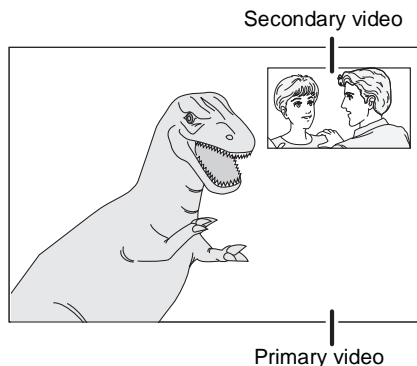

To turn on/off secondary audio
[DISPLAY] ⇒ select "Disc" ⇒ [▶] ⇒ select "Signal Type" ⇒ [OK] ⇒ set "Soundtrack" in "Secondary Video" to "On" or "Off"



- The usable functions and the operating method may vary with each disc, please refer to the instructions on the disc and/or visit their website.
- Some BD-Live content available on the Blu-ray discs may require an Internet account to be created in order to access the BD-Live content. Follow the screen display or instruction manual of the disc for information on acquiring an account.
- "BD-Live Internet Access" may need to be changed for certain discs (⇒ 22).
- When discs supporting BD-Live are played back, the player or disc IDs may be sent to the content provider via the Internet.
- During search/slow-motion or frame-by-frame, only the primary video is displayed.
- When "BD-Video Secondary Audio" in "Digital Audio Output" is set to "Off", secondary audio will not be played (⇒ 23).

Playing still pictures

BD DVD CD USB

(BD-RE, DVD-R/R DL, CD-R/RW, USB device)

1 Insert the media.

If the menu is displayed, press [**▲**, **▼**, **◀**, **▶**] to select the item. (⇒ 13)

2 Press [**▲**, **▼**, **◀**, **▶**] to select the still picture and press [**OK**].

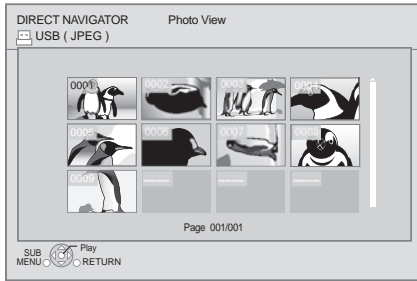

Press [**◀**, **▶**] to display the previous or next still picture.

To exit the screen

Press [**POP-UP MENU/TOP MENU**].

■ To show the still picture properties

While playing, press [**STATUS**] twice.

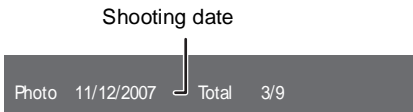

To exit the screen

Press [**STATUS**].

Useful functions

1 Press [**SUB MENU**].

2 Select an item, then press [**OK**].

While Photo View screen is displayed

Select Folder	To select the still pictures in another folder.
Start Slideshow	You can display still pictures one by one at a constant interval.
Slideshow Settings	Display Interval Change the display interval. Transition Effect Set display method. Repeat Play Repeat slideshow. Press [▲, ▼, ◀, ▶] to select “Set” and press [OK].

While playing

Rotate Right	Rotate the still picture.
Rotate Left	



- Depending on the condition of the unit and media contents, displayed items are different.
- When a still picture with large number of pixels is played, the display interval may become longer. Even if the setting is changed, the display interval may not become shorter.

Playing music

DVD CD USB

(DVD-R/-R DL, music CD, CD-R/RW, USB device)

1 Insert the media.

If the menu is displayed, press [▲, ▼, ◀, ▶] to select the item. (⇒ 13)

2 Press [▲, ▼] to select the track and press [OK].

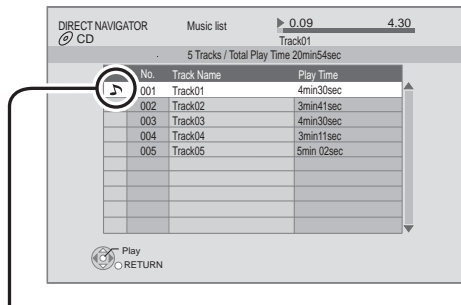

“🎵” indicates the track currently playing.

Playing a track in another folder

1 While the Direct Navigator screen is displayed Press [SUB MENU].

2 Press [▲, ▼] to select “Select Folder” and press [OK].



- You cannot select folders that contain no compatible tracks.

Enjoying Network Service

You can enjoy Network Service such as streaming movie, etc. (Current as of December 2010)

Preparation

- Network connection (⇒ 9)
- Network setting (⇒ 11)

1 Press [NETWORK].

- NETFLIX can be accessed directly by pressing [NETFLIX] button.

2 Press [▶] to select “Internet Content”.

- Message is displayed. Please read these instructions carefully and then press [OK].

3 Press [▲, ▼, ◀, ▶] to select the item and press [OK].

Operable buttons:

[▲, ▼, ◀, ▶], [OK], [RETURN], colored buttons, number buttons

The home screen;

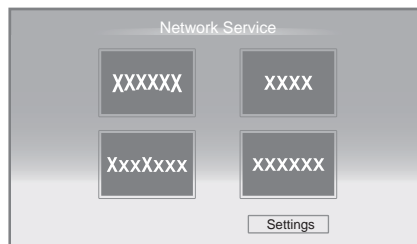

Images are for illustration purposes, contents may change without notice.

To exit from Network Service

Press [EXIT] or [HOME].



- When playing content from a disc and/or USB device Network Service cannot be accessed by pressing [NETWORK].
- Set “Lock” in “Internet Content Settings”, when restricting the use of Network Service (⇒ 24)
- If using slow Internet connection, the video may not be displayed correctly. A high-speed Internet service with a speed of at least 6 Mbps is recommended.
- Be sure to update the firmware when a firmware update notice is displayed on the screen. If the firmware is not updated, you will not be able to use Network Service function. (⇒ 12)

- Network Service home screen is subject to change without notice.
- The services through Network Service are operated by their respective service providers, and service may be discontinued either temporarily or permanently without notice. Therefore, Panasonic will make no warranty for the content or the continuity of the services.
- All features of websites or content of the service may not be available.
- Some content may be inappropriate for some viewers.
- Some content may only be available for specific countries and may be presented in specific languages.

Playing back contents on the DLNA server (DLNA)

You can enjoy viewing video, still pictures and music saved on a DLNA Certified media server connected to the home network with this unit.

– This feature is only supported by Windows 7 Operating system.

Preparation

- ① Perform network connection and network settings of this unit. (⇒ 9, 11)
- ② Perform Home Network settings of the PC.
 - Add the contents and folder to the Windows Media® Player library.
 - Playlist of Windows Media® Player can play back only the contents that are stored in the libraries.

For details about the setting and operation method of connected equipment, refer to the following Website and the operating instructions for each item of equipment.
<http://panasonic.jp/support/global/cs/>
(This site is in English only.)

To exit from Home Network

Press [EXIT], [HOME] or [POP-UP MENU/TOP MENU].



- Menu structure will be different depending on the equipment connected to this unit. Select the contents by repeating the operation.
- Depending on the contents and the connected equipment, playback may not be possible.
- Items displayed in gray on the display cannot be played back by this unit.
- This unit cannot be played back via connected equipment.
- Depending on the performance of the connected PC, video frames may be dropped during playback, or video may not playback at all.

1 Press [NETWORK].

2 Press [▲] to select “DLNA Client”.

- A list of equipment connected via the network is displayed.
- This list can be updated by pressing [R] on the remote control.

e.g.

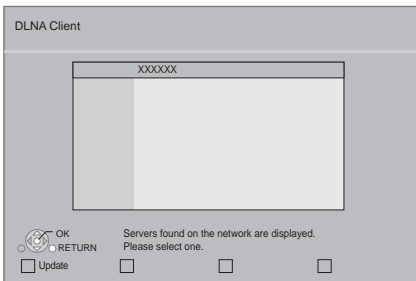

3 Press [▲, ▼] to select the equipment to playback the contents, and press [OK].

4 Press [▲, ▼, ◀, ▶] to select the item to playback (folder), and press [OK].

- You may be able to use convenient functions depending on the disc or content by pressing [SUB MENU] or [DISPLAY].

- Control Panel is displayed once the playback starts.

Operation can be performed with [▲, ▼, ◀, ▶], [OK] and [EXIT].

- Press [OK] if the Control Panel is not displayed.

- Press [RETURN] to hide the Control Panel.

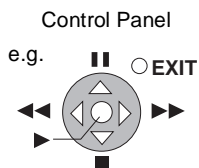

Linked operations with the TV

(VIERA Link™ “HDAVI Control™”)

What is VIERA Link “HDAVI Control”?

VIERA Link™ is a new name for EZ Sync™. VIERA Link “HDAVI Control” is a convenient function that offers linked operations of this unit, and a Panasonic TV (VIERA) or amplifier/receiver under “HDAVI Control”.

You can use this function by connecting the equipment with an HDMI cable. See the operating instructions for connected equipment for operational details.

Preparation

- ① Set “VIERA Link” to “On” (⇒ 24). (The default setting is “On”.)
 - ② Set the “HDAVI Control” operations on the connected equipment (e.g., TV).
 - ③ Turn on all “HDAVI Control” compatible equipment and select this unit’s input channel on the connected TV so that the “HDAVI Control” function works properly.
- Also when the connection or settings are changed, repeat this procedure.**

Automatic input switching Power on link

When play starts on the unit, the TV will automatically switch the input channel and display the corresponding action. Additionally when the TV is off, the TV will automatically turn on.

Power off link

All connected equipment compatible with “HDAVI Control”, including this unit, automatically turns off when you switch the television off.



- This unit supports “HDAVI Control 1” function. This standard is compatible with Panasonic’s conventional HDAVI equipment.
- VIERA Link “HDAVI Control”, based on the control functions provided by HDMI which is an industry standard known as HDMI CEC (Consumer Electronics Control), is a unique function that we have developed and added. As such, its operation with other manufacturers’ equipment that supports HDMI CEC cannot be guaranteed.
- Please refer to individual manuals for other manufacturers’ equipment supporting VIERA Link function.

Playback menu

1 Press [DISPLAY].

e.g., BD-Video



2 Press [▲, ▼] to select the menu and press [▶].

3 Press [▲, ▼, ◀, ▶] to select the item and press [▶].

4 Press [▲, ▼] to select the setting.

Some items can be changed by pressing [OK].

To exit the screen

Press [DISPLAY].

Depending on the condition of the unit (playing, stopped, etc.) and media contents, there may be some items that you cannot select or change.

Regarding Language : (⇒ 29)

Disc

Signal Type

Primary Video	Video	The recording method of original video appears.
	Soundtrack	Select the type of audio or language.
Secondary Video	Video	Select on/off of images. The recording method of original video appears.
	Soundtrack	Select on/off of audio and the language.

Video

The recording method of original video appears.

Soundtrack

Show or change the soundtrack.

Subtitle

Turn the subtitle on/off, and change the language depending on the media.

Subtitle Style

Select the subtitle style.

Audio channel

Select the audio channel number.
(⇒ 14, "Changing audio")

Angle

Select the number of the angle.



- Some items may be changed only on the disc specific menu. (⇒ 14)

Play

Repeat Play

(Only when the elapsed time is being displayed on the unit's display.)

Select the item which you want to repeat. The items displayed differ depending on the type of media.

Select "Off" to cancel.

Random

Select whether or not to play random.

Video

Picture

Select the picture quality mode during play.

- If you select "User", you can make further adjustments.
Press [▶] to select "Picture Adjustment" and press [OK].

Progressive

Select the method of conversion for progressive output to suit the type of material being played.

- When the content is distorted change the settings from "Auto" to "Video".

Setup menu

Change the unit's settings if necessary. The settings remain intact even if you switch the unit to standby.

- 1 Press [HOME].
- 2 Press [OK] to select "Setup".
- 3 Press [◀] to select "Player Settings".

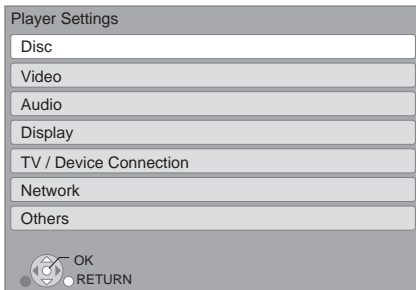

- 4 Press [▲, ▼] to select the menu and press [OK].
- 5 Press [▲, ▼] to select the item and press [OK].
If there are any other items, repeat these steps.
- 6 Press [▲, ▼, ◀, ▶] to select the option and press [OK].



- There may be differences in operation methods. If this happens, follow the on-screen instructions for the operation.

About the password

The following items use the same password.
Don't forget your password.

- "DVD-Video Ratings"
- "BD-Video Ratings"
- "Lock" (⇒ 24)

Disc

DVD-Video Ratings

Set a ratings level to limit DVD-Video play.

- Follow the on-screen instructions. Enter a 4-digit password with the number buttons when the password screen is shown.

BD-Video Ratings

Set an age limit of BD-Video play.

- Follow the on-screen instructions. Enter a 4-digit password with the number buttons when the password screen is shown.

Audio Language

Choose the language for audio.

- If "Original" is selected, the original language of each disc will be selected.
- Enter a code (⇒ 29) with the number buttons when you select "Other ****".

Subtitle Language

Choose the language for the subtitle.

- If "Automatic" is selected and the language selected for "Audio Language" is not available, subtitles of that language will automatically appear if available on that disc.
- Enter a code (⇒ 29) with the number buttons when you select "Other ****".

Menu Language

Choose the language for the disc menus.

- Enter a code (⇒ 29) with the number buttons when you select "Other ****".

BD-Live Internet Access (⇒ 16)

You can restrict Internet access when BD-Live functions are used.

- If "Allow (Limited)" is selected, Internet access is permitted only for BD-Live contents which have content owner certificates.

Mixed Data Disc Option

Select the playback contents on discs with both data files and Video.

- If "MP3/JPEG/MKV" is selected, the video menu function is unavailable.
- If "BD-RE/AVCHD" is selected, data file cannot be played back.

Subtitle Text

Select a suitable item according to the language used for MKV subtitles text.

- This item is displayed only after playing back a file.



- BDAV is one of the video formats that are recorded on a BD-RE/BD-R. (⇒ 6)

Video

Black Level Control

Select lighter or darker for adjusting the black level control to the desired setting for picture enhancement.

Audio

Dynamic Range Compression

You can listen at low volumes but still hear dialog clearly. (Dolby Digital, Dolby Digital Plus and Dolby TrueHD only)

- “Auto” is effective only when playing Dolby TrueHD.

Digital Audio Output

Press [OK] to show the following settings:

Dolby D/Dolby D +/Dolby TrueHD DTS/DTS-HD

Select the audio signal to output.

- Select “PCM”, when the connected equipment cannot decode the respective audio format. This unit decodes the audio format and transmits to the connected equipment.
- Not making the proper settings may result in noise.

BD-Video Secondary Audio

Select whether to mix or not mix the primary audio and secondary audio (including the button click sound). (⇒ 16)

- If “Off” is selected, the unit outputs the primary audio only.

Downmix

Select the downmix system of multi-channel to 2-channel sound.

- Select “Surround encoded”, when the connected equipment supports the virtual surround function.
- There is no effect on “Bitstream” via HDMI AV OUT.
- The audio will be output in “Stereo” in the following cases:
 - AVCHD playback
 - Playback of secondary audio (including the button click sound).

Display

Status Messages

Choose whether to show status messages automatically.

On-screen Language

Choose the language for menus and on-screen messages.

Screen Saver Function

This is to prevent burn-in on the screen.

- When this is set to “On”:
 - If there is no operation for 10 minutes or more, Direct Navigator screen switches to HOME menu automatically.
- While playing and pausing, etc., this function is not available.
- As for Music [CD-DA] or MP3, regardless of the setting, if there is no operation for a while, Direct Navigator screen switches to the other states automatically.

Front Panel Display

Changes the brightness of the unit’s display.

- If “Auto” is selected the display is dimmed during playback and bright not during playback.

License



Information about the software used by this unit is displayed.

TV / Device Connection

TV Aspect

Set to match the type of television connected.

When connected to a 4:3 aspect television and playing 16:9 ratio image:

4:3 Pan & Scan	The sides are cut off so the picture fills the screen. When playing BD-Video, video is output as “4:3 Letterbox”.	
4:3 Letterbox	Black bands appear at the top and bottom of the picture.	

When connected to a 16:9 widescreen television and playing 4:3 ratio image:

16:9	Video is displayed as a 4:3 ratio image in the center of the screen.
16:9 Full	Video is displayed as a horizontally stretched 16:9 image.

HDMI Connection

Press [OK] to show the following settings:

HDMI Resolution

The items supported by the connected devices are indicated on the screen as “*”. When any item without “*” is selected, the images may be distorted.

- If “Auto” is selected, automatically selects the output resolution best suited to the connected television.
- To enjoy high-definition video up-converted to 1080p, you need to connect the unit directly to 1080p compatible HDTV (High Definition Television). If this unit is connected to an HDTV through other equipment, it must also be 1080p compatible.

24p Output

When this unit is connected to a TV supporting 1080/24p output using an HDMI cable, movies and other material recorded at 24p are output at 24p.

- When BD-Video images other than 24p are played, images are output at 60p.
- 24p :
A progressive image recorded at a rate of 24 frames per second (motion-picture film). Many BD-Video movie contents are recorded in 24 frames/second in accordance with the film materials.

HDMI Audio Output

This setting selects whether or not to output audio from HDMI.

VIERA Link

Set to use “HDAVI Control” function when connected with an HDMI cable to a device that supports “HDAVI Control”.

- Select “Off” when you do not want to use “HDAVI Control”.

Deep Color Output

This setting is for selecting whether to use Deep Color output when a television that supports Deep Color is connected.

Contents Type Flag

Depending on the playback content, the TV will output adjusting to the optimal method when a TV that supports this function is connected.

Network

Network Easy Setting (⇒ 11)

Network Settings

Perform network-related settings individually.
Press [OK] to show the following settings:

IP Address/DNS Settings

This is for checking the state of the network connection and setting the IP address and DNS-related.

Press [OK] to show the respective setting.

- “Connection Speed Setting” is enabled only when “Auto Detect Connection Speed” is turned “Off”.

Proxy Server Settings

This is for checking the state of connection with the Proxy server and performing settings.

Press [OK] to show the respective setting.

Internet Content Settings (⇒ 18) (Network Service)

Press [OK] to show the following settings:

Lock

You can restrict the usage of Network Service.

- Follow the on-screen instructions. Enter a 4-digit password with the number buttons when the password screen is shown.

MAC Address

Displays the MAC address of this unit.

Remote Control Code

Change the remote control code if other Panasonic products react to this remote control.

Quick Start

Speed of startup from power off is increased.

- Internal control unit will be powered when it is set to "On" so compared to when the setting is "Off" the following will occur.
 - Idle power consumption will increase. (about the power consumption ⇨ 30)

Easy Setting

You can execute basic settings ("On-screen Language", "TV Aspect", "Quick Start")

Restore Default Settings

This returns all values in the Setup menu and the Playback menu, except for "Remote Control Code", "On-screen Language", "IP Address/DNS Settings", "Proxy Server Settings", "Lock", "DVD-Video Ratings" and "BD-Video Ratings" etc. to the default settings.

System Information

Display firmware version of this unit.

Firmware Update (⇨ 12)

Press [OK] to show the following settings:

Automatic Update Check

When this equipment remains connected to the Internet, it will check for the latest firmware version when it is turned on and you can update it if necessary.

Update Now

You can update the firmware manually if a firmware update is available.

Troubleshooting guide

Before requesting service, please perform the following steps.

Do you have the latest firmware installed?

Firmware updates may be released to correct operating irregularities that are discovered with certain movies.
(⇒ 12)

Make the following checks and visit our website for more information.

For USA :

www.panasonic.com/help

Enter the model number.

For Canada :

<http://www.panasonic.ca>

Or visit our website to find a service center.

You can find a service center near you easily on our website.

Other support information:

"Customer Services Directory (United States and Puerto Rico)" (⇒ 33) or "Limited Warranty (Only for CANADA)" (⇒ 34).

The following do not indicate a problem with this unit:

- Regular disc rotating sounds.
- Image disturbance during search.

■ Unit doesn't respond to remote control or front panel buttons.

Disconnect the power cord, wait 1 minute, then reconnect the power cord.

■ Cannot eject disc.

The unit may have a problem.

- ① While the unit is on, press and hold [OK], [B] and [Y] on the remote control at the same time for more than 5 seconds.
 - "00 rEt" is displayed on the unit's display.
- ② Repeatedly press [▶] (right) on the remote control or [POWER ⏻/⏪] on the unit until "06 FtO" is displayed on the unit's display.
- ③ Press [OK] on the remote control or [▲ OPEN/CLOSE] on the unit.

General operation

To return to the factory preset.

- Select "Yes" in "Restore Default Settings" in the Setup menu. (⇒ 25)

To return all settings to the factory preset.

- Reset the unit as follows:
- ① While the unit is on, press and hold [OK], [B] and [Y] on the remote control at the same time for more than 5 seconds.
 - "00 rEt" is displayed on the unit's display.
 - ② Repeatedly press [▶] (right) on the remote control or [POWER ⏻/⏪] on the unit until "08 Fln" is displayed on the unit's display.
 - ③ Press and hold [OK] on the remote control or [▲ OPEN/CLOSE] on the unit for at least 4 seconds.

The remote control doesn't work properly.

- Change the batteries for the remote control. (⇒ 4)
- The remote control and main unit are using different codes. If "SEt □" is displayed on the unit's display when a button is pressed on the remote control, change the code on the remote control. (⇒ 25)

The TV tuner mode is not displayed when the TV is switched on.

- This phenomenon may occur, depending on the TV setting, when "Quick Start" is set to "On".
- Depending on the TV, this phenomenon may be prevented by reconnecting the HDMI cable to a different HDMI input terminal or by changing the HDMI auto connection setting.

You have forgotten your ratings password. You want to cancel the ratings level.

- The ratings level returns to the factory preset.
- ① While the unit is on, press and hold [OK], [B] and [Y] on the remote control at the same time for more than 5 seconds.
 - "00 rEt" is displayed on the unit's display.
 - ② Repeatedly press [▶] (right) on the remote control or [POWER ⏻/⏪] on the unit until "03 VL" is displayed on the unit's display.
 - ③ Press [OK] on the remote control or [▲ OPEN/CLOSE] on the unit.

This unit does not recognize the USB connection correctly.

- If inserted during playback the USB device may not be recognized by this unit.
- Disconnect and reconnect the USB cable. If it still does not recognize the connection, turn the power of this unit off and on again.
- USB devices connected using a USB hub may not be recognized by this unit.
- If you connect USB HDD to this unit, use USB extension cable that is supplied with the HDD.

Picture

The images from this unit do not appear on the television.

Picture is distorted.

- An incorrect resolution is selected in “HDMI Resolution”. Reset the setting as follows:
 - ① While the unit is on, press and hold [OK], [B] and [Y] on the remote control at the same time for more than 5 seconds.
 - “00 rEt” is displayed on the unit’s display.
 - ② Repeatedly press [▶] (right) on the remote control or [POWER ⏻/I] on the unit until “04 PrG” is displayed on the unit’s display.
 - ③ Press and hold [OK] on the remote control or [▲ OPEN/CLOSE] on the unit for at least 4 seconds.
 - Set the item again. (⇒ 24)
- When Dolby Digital Plus, Dolby TrueHD, and DTS-HD audio are not output in bitstream, select “Yes” in “Restore Default Settings” and make proper settings. (⇒ 25)

Video is not output in high-definition.

- Confirm that “HDMI Resolution” in the Setup menu is set properly. (⇒ 24)

No subtitles.

- When progressive output is on, closed captions/subtitles cannot be displayed.

The subtitles overlap closed captions recorded on discs.

- Turn off the subtitles or turn off the closed caption setting on the TV. (⇒ 21)

A black band is displayed around the edge of the screen.

The aspect ratio of the screen is abnormal.

- Confirm the “TV Aspect” is set properly. (⇒ 23)
- Adjust the aspect setting on the television.

Audio

Cannot hear the desired audio type.

- Check the connections and the “Digital Audio Output” settings. (⇒ 9, 23)
- To output audio from a device connected with an HDMI cable, set “HDMI Audio Output” to “On” in the Setup menu. (⇒ 24)

Playback

Disc cannot be played.

- The disc is dirty. (⇒ 4)

Still pictures (JPEG) do not play back normally.

- The images that were edited on the PC, such as Progressive JPEG, etc., may not play back.

I can’t play back BD-Live.

- Confirm that this unit is connected to the broadband Internet. (⇒ 9)
- Confirm the “BD-Live Internet Access” settings. (⇒ 22)
- Confirm a USB device is inserted into the USB port. (⇒ 13)

Network

I can’t connect to the network.

- Confirm the network connection and settings. (⇒ 9, 11, 24)
- Check the operating instructions for each device and connect accordingly.

Messages

The following messages or service numbers appear on the television or unit's display when something unusual is detected during startup and use.

On the television

Cannot play.

- You inserted an incompatible disc (Discs recorded in PAL video, etc.).

Cannot display on this unit.

- You tried to play a non-compatible image.

No disc is inserted.

- The disc may be upside down.

⊘ This operation is not available.

- Some operations are unsupported by the unit. For example;
 - BD-Video: During playback, reverse slow-motion or reverse frame-by-frame is not possible.

IP address is not set.

- The "IP Address" in "IP Address/DNS Settings" is "---. ---. ---. ---". Set the "IP Address", "Subnet Mask", and "Default Gateway". (Select the automatic address acquisition if necessary.)

On the unit's display

SEt □

("□" stands for a number.)

- The remote control and main unit are using different codes. Change the code on the remote control.

Press and hold [OK] and the indicated number button at the same time for more than 5 seconds.



H□□ or F□□

("□" stands for a number.)

- There is something unusual.
- Check the unit using the troubleshooting guide. If the service number does not disappear, do the following.

- ① Disconnect the plug from the AC outlet, wait a few seconds, then reconnect it.
- ② Press [POWER ⏻/⏻] to turn the power on.

If the service number does not disappear despite doing the above, request service from the dealer. Inform the dealer of the service number when requesting service.

Supplemental information

■ Display languages list

Display Language	Display Language	Display Language
ENG English	JPN Japanese	ARA Arabic
FRA French	CHI Chinese	HIN Hindi
DEU German	KOR Korean	PER Persian
ITA Italian	MAL Malay	IND Indonesian
ESP Spanish	VIE Vietnamese	MRI Maori
NLD Dutch	THA Thai	BUL Bulgarian
SVE Swedish	POL Polish	RUM Romanian
NOR Norwegian	CES Czech	GRE Greek
DAN Danish	SLK Slovak	TUR Turkish
POR Portuguese	HUN Hungarian	* Others
RUS Russian	FIN Finnish	

■ Language code list

Language Code	Language Code	Language Code
Abkhazian: 6566	Gujarati: 7185	Rhaeto-Romance: 8277
Afar: 6565	Hausa: 7265	Romanian: 8279
Afrikaans: 6570	Hebrew: 7387	Russian: 8285
Albanian: 8381	Hindi: 7273	Samoan: 8377
Amharic: 6577	Hungarian: 7285	Sanskrit: 8365
Arabic: 6582	Icelandic: 7383	Scots Gaelic: 7168
Armenian: 7289	Indonesian: 7378	Serbian: 8382
Assamese: 6583	Interlingua: 7365	Serbo-Croatian: 8372
Aymara: 6589	Irish: 7165	Shona: 8378
Azerbaijani: 6590	Italian: 7384	Sindhi: 8368
Bashkir: 6665	Japanese: 7465	Singhalese: 8373
Basque: 6985	Javanese: 7487	Slovak: 8375
Bengali; Bangla: 6678	Kannada: 7578	Slovenian: 8376
Bhutani: 6890	Kashmiri: 7583	Somali: 8379
Bihari: 6672	Kazakh: 7575	Spanish: 6983
Breton: 6682	Kirghiz: 7589	Sundanese: 8385
Bulgarian: 6671	Korean: 7579	Swahili: 8387
Burmese: 7789	Kurdish: 7585	Swedish: 8386
Byelorussian: 6669	Laotian: 7679	Tagalog: 8476
Cambodian: 7577	Latin: 7665	Tajik: 8471
Catalan: 6765	Latvian, Lettish: 7686	Tamil: 8465
Chinese: 9072	Lingala: 7678	Tatar: 8484
Corsican: 6779	Lithuanian: 7684	Telugu: 8469
Croatian: 7282	Macedonian: 7775	Thai: 8472
Czech: 6783	Malagasy: 7771	Tibetan: 6679
Danish: 6865	Malay: 7783	Tigrinya: 8473
Dutch: 7876	Malayalam: 7776	Tonga: 8479
English: 6978	Maltese: 7784	Turkish: 8482
Esperanto: 6979	Maori: 7773	Turkmen: 8475
Estonian: 6984	Marathi: 7782	Twi: 8487
Faroese: 7079	Moldavian: 7779	Ukrainian: 8575
Fiji: 7074	Mongolian: 7778	Urdu: 8582
Finnish: 7073	Nauru: 7865	Uzbek: 8590
French: 7082	Nepali: 7869	Vietnamese: 8673
Frisian: 7089	Norwegian: 7879	Volapük: 8679
Galician: 7176	Oriya: 7982	Welsh: 6789
Georgian: 7565	Pashto, Pushto: 8083	Wolof: 8779
German: 6869	Persian: 7065	Xhosa: 8872
Greek: 6976	Polish: 8076	Yiddish: 7473
Greenlandic: 7576	Portuguese: 8084	Yoruba: 8979
Guarani: 7178	Punjabi: 8065	Zulu: 9085
	Quechua: 8185	

■ Unit's display list

This list only contains displays that are difficult to read.

Display	Reading	Display	Reading
BYE	BYE	OPEN	OPEN
READ	READ	PLAY	PLAY
STOP	STOP	SETUP	SETUP
NET	NET	F99	F99
noPLAY	No PLAY	noUPDATE	No UPDATE
SET 2	SET □*	START	START
UPd 1-5	UPD□-5*	FINISH	FINISH
STILLP	STILLP	P-LIST	P-LIST
SLIDE	SLIDE	REPEAT	REPEAT
noDISC	No DISC	noPLAY	No PLAY
noREAD	No READ	UNLOCK	UNLOCK
BD-J	BD-J	DISC	DISC
-----	UNSUPPORT		

* "□" stands for a number.

Specifications

Signal system:	NTSC
Operating temperature range:	+5 °C to +35 °C (+41 °F to +95 °F)
Operating humidity range:	10 % to 80 % RH (no condensation)
Video output:	1.0 Vp-p (75 Ω)/Pin jack:1 system
Audio output:	2 Vrms (1 kHz, 0 dB)/Pin jack
Number of connectors :	2 channel:1 system
HDMI AV output:	Type A (19 pin) : 1 system
	This unit supports "HDAVI Control1" function.
USB slot:	USB2.0 : 1 system
Ethernet:	10BASE-T/100BASE-TX : 1 system
LASER Specification	
Class I LASER Product:	
Wave length:	790 nm (CDs)/655 nm (DVDs)/405 nm (BDs)
Laser power:	No hazardous radiation is emitted with the safety protection
Power supply:	AC 120 V, 60 Hz
Power consumption:	Approx. 12 W
Power consumption in standby mode:	Approx. 0.1 W
Power consumption in quick start standby mode:	Approx. 3.3 W
Dimensions (W×D×H) Including the projecting parts:	
	430 mm×185 mm×35 mm
	(Approx. 16 15/16"×7 5/16"×1 7/16")
Mass (Weight):	Approx. 1.6 kg (3.52 lbs)

Specifications are subject to change without notice.

File format

File format	Extension	Reference
MP3	“.MP3”, “.mp3”	ID3 tags (Only titles and the names of artists)
JPEG	“.JPG”, “.jpg”	<ul style="list-style-type: none"> ● MOTION JPEG and Progressive JPEG is not supported ● You may not be able to play back the file if you have edited the folder structure or the file name on a PC or other device.
MKV	“.MKV”, “.mkv” Subtitles text file “.SRT”, “.srt”, “.SSA”, “.ssa”, “.ASS”, “.ass”	<ul style="list-style-type: none"> ● The video file and subtitles text file are inside the same folder, and the file names are the same except for the file extensions. ● Some MKV file may not be played back, depending on the video resolution and frame rate condition.

- With certain recording states and folder structures, the play order may differ or playback may not be possible.

Audio information

The audio output differs depending on the settings on the unit. (⇒ 23, Digital Audio Output)

- The number of channels listed is the maximum possible number of output channels when connected to amplifier/receiver compatible with the respective audio format.

Terminal	“Digital Audio Output”	
	“Bitstream”	“PCM” ^{*2}
HDMI AV OUT	Outputs using original audio ^{*1}	BD-Video : 7.1ch PCM ^{*1} DVD-Video : 5.1ch PCM

^{*1} When “BD-Video Secondary Audio” is set to “On”, the audio is output as Dolby Digital, DTS Digital Surround or 5.1ch PCM.

^{*2} The maximum possible number of Dolby sound is 2ch PCM.

This product incorporates the following software:

- (1) the software developed independently by or for Panasonic Corporation,
- (2) the software owned by third party and licensed to Panasonic Corporation,
- (3) the software licensed under the GNU General Public License, Version 2 (GPL v2),
- (4) the software licensed under the GNU LESSER General Public License, Version 2.1 (LGPL v2.1) and/or,
- (5) open sourced software licensed under its applicable license terms including but not limited to ICU License, c-arse license, gSOAP Public License 1.3b

For the software categorized as (3) and (4), please refer to the terms and conditions of GPL v2 and LGPL v2.1, as the case may be at <http://www.gnu.org/licenses/old-licenses/gpl-2.0.html> and <http://www.gnu.org/licenses/old-licenses/lgpl-2.1.html>. In addition, the software categorized as (3) and (4) are copyrighted by several individuals. Please refer to the copyright notice of those individuals at <http://www.am-linux.jp/dl/AWBP11>

The GPL/LGPL software is distributed in the hope that it will be useful, but WITHOUT ANY WARRANTY, without even the implied warranty of MERCHANTABILITY or FITNESS FOR A PARTICULAR PURPOSE.

At least three (3) years from delivery of products, Panasonic will give to any third party who contacts us at the contact information provided below, for a charge no more than our cost of physically performing source code distribution, a complete machine-readable copy of the corresponding source code covered under GPL v2/LGPL v2.1.

Contact Information
cdrequest@am-linux.jp

Source code is also freely available to you and any other member of the public via our website below.
<http://www.am-linux.jp/dl/AWBP11>

For Open Source Software Programs categorized as (5), please refer to the applicable license terms listed below and/or included in the "License" menu on Product.

ICU License - ICU 1.8.1 and later

COPYRIGHT AND PERMISSION NOTICE

Copyright (c) 1995-2010 International Business Machines Corporation and others

All rights reserved.

Permission is hereby granted, free of charge, to any person obtaining a copy of this software and associated documentation files (the "Software"), to deal in the Software without restriction, including without limitation the rights to use, copy, modify, merge, publish, distribute, and/or sell copies of the Software, and to permit persons to whom the Software is furnished to do so, provided that the above copyright notice(s) and this permission notice appear in all copies of the Software and that both the above copyright notice(s) and this permission notice appear in supporting documentation.

THE SOFTWARE IS PROVIDED "AS IS", WITHOUT WARRANTY OF ANY KIND, EXPRESS OR IMPLIED, INCLUDING BUT NOT LIMITED TO THE WARRANTIES OF MERCHANTABILITY, FITNESS FOR A PARTICULAR PURPOSE AND NONINFRINGEMENT OF THIRD PARTY RIGHTS. IN NO EVENT SHALL THE COPYRIGHT HOLDER OR HOLDERS INCLUDED IN THIS NOTICE BE LIABLE FOR ANY CLAIM, OR ANY SPECIAL INDIRECT OR CONSEQUENTIAL DAMAGES, OR ANY DAMAGES WHATSOEVER RESULTING FROM LOSS OF USE, DATA OR PROFITS, WHETHER IN AN ACTION OF CONTRACT, NEGLIGENCE OR OTHER TORTIOUS ACTION, ARISING OUT OF OR IN CONNECTION WITH THE USE OR PERFORMANCE OF THIS SOFTWARE.

Except as contained in this notice, the name of a copyright holder shall not be used in advertising or otherwise to promote the sale, use or other dealings in this Software without prior written authorization of the copyright holder.

All trademarks and registered trademarks mentioned herein are the property of their respective owners.

c-arse license

Copyright 1998 by the Massachusetts Institute of Technology.

Permission to use, copy, modify, and distribute this software and its documentation for any purpose and without fee is hereby granted, provided that the above copyright notice appear in all copies and that both that copyright notice and this permission notice appear in supporting documentation, and that the name of M.I.T. not be used in advertising or publicity pertaining to distribution of the software without specific, written prior permission.

M.I.T. makes no representations about the suitability of this software for any purpose. It is provided "as is" without express or implied warranty.

gSOAP Public License Version 1.3b

Part of the software embedded in this product is gSOAP software. Portions created by gSOAP are Copyright (C) 2001-2009 Robert A. van Engelen, Genivia inc. All Rights Reserved.

THE SOFTWARE IN THIS PRODUCT WAS IN PART PROVIDED BY GENIVIA INC AND ANY EXPRESS OR IMPLIED WARRANTIES, INCLUDING, BUT NOT LIMITED TO, THE IMPLIED WARRANTIES OF MERCHANTABILITY AND FITNESS FOR A PARTICULAR PURPOSE ARE DISCLAIMED. IN NO EVENT SHALL THE AUTHOR BE LIABLE FOR ANY DIRECT, INDIRECT, INCIDENTAL, SPECIAL, EXEMPLARY, OR CONSEQUENTIAL DAMAGES (INCLUDING, BUT NOT LIMITED TO, PROCUREMENT OF SUBSTITUTE GOODS OR SERVICES; LOSS OF USE, DATA, OR PROFITS; OR BUSINESS INTERRUPTION) HOWEVER CAUSED AND ON ANY THEORY OF LIABILITY, WHETHER IN CONTRACT, STRICT LIABILITY, OR TORT (INCLUDING NEGLIGENCE OR OTHERWISE) ARISING IN ANY WAY OUT OF THE USE OF THIS SOFTWARE, EVEN IF ADVISED OF THE POSSIBILITY OF SUCH DAMAGE.

Java and all Java-based trademarks and logos are trademarks or registered trademarks of Sun Microsystems, Inc. in the United States and other countries.

Manufactured under license from Dolby Laboratories.
Dolby and the double-D symbol are trademarks of Dolby Laboratories.

Manufactured under license under U.S. Patent #'s: 5,451,942; 5,956,674; 5,974,380; 5,978,762; 6,226,616; 6,487,535; 7,392,195; 7,272,567; 7,333,929; 7,212,872 & other U.S. and worldwide patents issued & pending.
DTS and the Symbol are registered trademarks, & DTS-HD, DTS-HD Master Audio | Essential and the DTS logos are trademarks of DTS, Inc. Product includes software.
© DTS, Inc. All Rights Reserved.

This item incorporates copy protection technology that is protected by U.S. patents and other intellectual property rights of Rovi Corporation. Reverse engineering and disassembly are prohibited.

HDMI, the HDMI Logo, and High-Definition Multimedia Interface are trademarks or registered trademarks of HDMI Licensing LLC in the United States and other countries.

This product is licensed under the AVC patent portfolio license and VC-1 patent portfolio license for the personal and non-commercial use of a consumer to (i) encode video in compliance with the AVC Standard and VC-1 Standard ("AVC/VC-1 Video") and/or (ii) decode AVC/VC-1 Video that was encoded by a consumer engaged in a personal and non-commercial activity and/or was obtained from a video provider licensed to provide AVC/VC-1 Video. No license is granted or shall be implied for any other use. Additional information may be obtained from MPEG LA, LLC.
See <http://www.mpegla.com>.

HDAVI Control™ is a trademark of Panasonic Corporation.

VIERA Link™ is a trademark of Panasonic Corporation.

EZ Sync™ is a trademark of Panasonic Corporation.

MPEG Layer-3 audio coding technology licensed from Fraunhofer IIS and Thomson.

"AVCHD" and the "AVCHD" logo are trademarks of Panasonic Corporation and Sony Corporation.

"DVD Logo" is a trademark of DVD Format/Logo Licensing Corporation.

DLNA, the DLNA Logo and DLNA CERTIFIED are trademarks, service marks, or certification marks of the Digital Living Network Alliance.

Windows is a trademark or a registered trademark of Microsoft Corporation in the United States and other countries.

Limited Warranty (ONLY FOR U.S.A. AND PUERTO RICO)

Panasonic Consumer Electronics Company,
Division of Panasonic Corporation of North America
One Panasonic Way, Secaucus, New Jersey 07094

Panasonic Blu-ray and DVD Products Limited Warranty

Limited Warranty Coverage (For USA and Puerto Rico Only)

If your product does not work properly because of a defect in materials or workmanship, Panasonic Consumer Electronics Company (referred to as "the warrantor") will, for the length of the period indicated on the chart below, which starts with the date of original purchase ("warranty period"), at its option either (a) repair your product with new or refurbished parts, (b) replace it with a new or a refurbished equivalent value product, or (c) refund your purchase price. The decision to repair, replace or refund will be made by the warrantor.

Product or Part Name	Parts	Labor
Blu-ray Disc Player, Portable Blu-ray Disc Player	1 year	90 days
Blu-ray Home Theater System	1 year	1 year
DVD Player, Portable DVD Player	1 year	90 days
DVD Recorder	1 year	90 days
Rechargeable Batteries (pack), DVD-RAM Disc (defective exchange)	10 days	Not Applicable

During the "Labor" warranty period there will be no charge for labor. During the "Parts" warranty period, there will be no charge for parts. This Limited Warranty excludes both parts and labor for non-rechargeable batteries, antennas, and cosmetic parts (cabinet). This warranty only applies to products purchased and serviced in the United States or Puerto Rico. This warranty is extended only to the original purchaser of a new product which was not sold "as is".

Mail-In Service

For assistance in the U.S.A. and Puerto Rico in obtaining repairs, please ship the product prepaid to:

Panasonic Exchange Center
4900 George McVay Drive
Suite B
McAllen, TX 78503
panacare@us.panasonic.com

When shipping the unit, carefully pack, include all accessories, and send it prepaid, adequately insured and preferably in the original carton. If Lithium Ion batteries are shipped by air the package must be labeled "Contains Lithium Ion Battery (No lithium metal)". Damaged batteries are prohibited from shipment by US Mail. Batteries must be securely packed in a manner to prevent short-circuiting and a package cannot contain more than 3 Lithium Ion batteries. Include a letter detailing the complaint, a return address and provide a daytime phone number where you can be reached. A valid registered receipt is required under the Limited Warranty.

IF REPAIR IS NEEDED DURING THE WARRANTY PERIOD, THE PURCHASER WILL BE REQUIRED TO FURNISH A SALES RECEIPT/PROOF OF PURCHASE INDICATING DATE OF PURCHASE, AMOUNT PAID AND PLACE OF PURCHASE. CUSTOMER WILL BE CHARGED FOR THE REPAIR OF ANY UNIT RECEIVED WITHOUT SUCH PROOF OF PURCHASE.

Limited Warranty Limits And Exclusions

This warranty ONLY COVERS failures due to defects in materials or workmanship, and DOES NOT COVER normal wear and tear or cosmetic damage. The warranty ALSO DOES NOT COVER damages which occurred in shipment, or failures which are caused by products not supplied by the warrantor, or failures which result from accidents, misuse, abuse, neglect, mishandling, misapplication, alteration, faulty installation, set-up adjustments, misadjustment of consumer controls, improper maintenance, power line surge, lightning damage,

modification, introduction of sand, humidity or liquids, commercial use such as hotel, office, restaurant, or other business or rental use of the product, or service by anyone other than a Factory Service Center or other Authorized Servicer, or damage that is attributable to acts of God.

THERE ARE NO EXPRESS WARRANTIES EXCEPT AS LISTED UNDER "LIMITED WARRANTY COVERAGE".

THE WARRANTOR IS NOT LIABLE FOR INCIDENTAL OR CONSEQUENTIAL DAMAGES RESULTING FROM THE USE OF THIS PRODUCT, OR ARISING OUT OF ANY BREACH OF THIS WARRANTY.

(As examples, this excludes damages for lost time, travel to and from the servicer, loss of or damage to media or images, data or other memory or recorded content. The items listed are not exclusive, but for illustration only.)

ALL EXPRESS AND IMPLIED WARRANTIES, INCLUDING THE WARRANTY OF MERCHANTABILITY, ARE LIMITED TO THE PERIOD OF THE LIMITED WARRANTY.

Some states do not allow the exclusion or limitation of incidental or consequential damages, or limitations on how long an implied warranty lasts, so the exclusions may not apply to you.

This warranty gives you specific legal rights and you may also have other rights which vary from state to state. If a problem with this product develops during or after the warranty period, you may contact your dealer or Service Center. If the problem is not handled to your satisfaction, then write to the warrantor's Consumer Affairs Department at the addresses listed for the warrantor.

PARTS AND SERVICE, WHICH ARE NOT COVERED BY THIS LIMITED WARRANTY, ARE YOUR RESPONSIBILITY.

Customer Services Directory (United States and Puerto Rico)

Obtain Product Information and Operating Assistance; locate your nearest Dealer or Service Center; purchase Parts and Accessories; or make Customer Service and Literature requests by visiting our Web Site at:

<http://www.panasonic.com/help>

or, contact us via the web at:

<http://www.panasonic.com/contactinfo>

You may also contact us directly at:

1-800-211-PANA (7262)

Monday-Friday 9am-9pm,

Saturday-Sunday 10am-7pm EST

**For hearing or speech impaired TTY users, TTY:
1-877-833-8855**

Accessory Purchases (United States and Puerto Rico)

Purchase Parts, Accessories and Instruction Books online for all Panasonic Products by visiting our Web Site at:

<http://www.pstc.panasonic.com>

Or, send your request by E-mail to:

npcparts@us.panasonic.com

You may also contact us directly at:

1-800-332-5368 (Phone) 1-800-237-9080 (Fax Only)

(Monday-Friday 9am-9pm EST)

Panasonic Service and Technology Company

20421 84th Avenue South, Kent, WA 98032

(We accept Visa, MasterCard, Discover Card, American Express, and Personal Checks)

**For hearing or speech impaired TTY users, TTY:
1-866-605-1277**

As of November 2009

User memo:

DATE OF PURCHASE _____
DEALER NAME _____
DEALER ADDRESS _____
TELEPHONE NUMBER _____

The model number and serial number of this product can be found on either the back or the bottom of the unit. Please note them in the space provided below and keep for future reference.

MODEL NUMBER _____ DMP-BD75 _____
SERIAL NUMBER _____

Limited Warranty (Only for CANADA)

Panasonic Canada Inc.
5770 Ambler Drive, Mississauga, Ontario L4W 2T3

PANASONIC PRODUCT - LIMITED WARRANTY

Panasonic Canada Inc. warrants this product to be free from defects in material and workmanship under normal use and for a period as stated below from the date of original purchase agrees to, at its option either (a) repair your product with new or refurbished parts, (b) replace it with a new or a refurbished equivalent value product, or (c) refund your purchase price. The decision to repair, replace or refund will be made by Panasonic Canada Inc.

Technics Audio Product - One (1) year, parts and labour
Panasonic BD/DVD Product - One (1) year, parts and labour
Panasonic Audio Receivers - One (1) year, parts and labour
Home Theater Systems Product - One (1) year, parts and labour

This warranty is given only to the original purchaser, or the person for whom it was purchased as a gift, of a Panasonic brand product mentioned above sold by an authorized Panasonic dealer in Canada and purchased and used in Canada, which product was not sold "as is", and which product was delivered to you in new condition in the original packaging.

IN ORDER TO BE ELIGIBLE TO RECEIVE WARRANTY SERVICE HEREUNDER, A PURCHASE RECEIPT OR OTHER PROOF OF DATE OF ORIGINAL PURCHASE, SHOWING AMOUNT PAID AND PLACE OF PURCHASE IS REQUIRED

LIMITATIONS AND EXCLUSIONS

This warranty ONLY COVERS failures due to defects in materials or workmanship, and DOES NOT COVER normal wear and tear or cosmetic damage. The warranty ALSO DOES NOT COVER damages which occurred in shipment, or failures which are caused by products not supplied by Panasonic Canada Inc., or failures which result from accidents, misuse, abuse, neglect, mishandling, misapplication, alteration, faulty installation, set-up adjustments, misadjustment of consumer controls, improper maintenance, power line surge, lightning damage, modification, introduction of sand, humidity or liquids, commercial use such as hotel, office, restaurant, or other business or rental use of the product, or service by anyone other than an Authorized Servicer, or damage that is attributable to acts of God.

Dry cell batteries are also excluded from coverage under this warranty.

THIS EXPRESS, LIMITED WARRANTY IS IN LIEU OF ALL OTHER WARRANTIES, EXPRESS OR IMPLIED, INCLUDING ANY IMPLIED WARRANTIES OF MERCHANTABILITY AND FITNESS FOR A PARTICULAR PURPOSE. IN NO EVENT WILL PANASONIC CANADA INC. BE LIABLE FOR ANY SPECIAL, INDIRECT OR CONSEQUENTIAL DAMAGES RESULTING FROM THE USE OF THIS PRODUCT OR ARISING OUT OF ANY BREACH OF ANY EXPRESS OR IMPLIED WARRANTY. (As examples, this warranty excludes damages for lost time, travel to and from the Authorized Servicer, loss of or damage to media or images, data or other memory or recorded content. This list of items is not exhaustive, but for illustration only.)

In certain instances, some jurisdictions do not allow the exclusion or limitation of incidental or consequential damages, or the exclusion of implied warranties, so the above limitations and exclusions may not be applicable. This warranty gives you specific legal rights and you may have other rights which vary depending on your province or territory.

WARRANTY SERVICE

For product operation and information assistance, please contact:

PRODUCT OPERATION ASSISTANCE

Customer Care Centre: Telephone #: 1-800-561-5505
Fax #: (905) 238-2360
Email link: "Support → contact us → email" on www.panasonic.ca

PRODUCT REPAIRS

Please locate your nearest Authorized Servicentre.

Link: "Support → Panasonic Servicentre® locator" on www.panasonic.ca

IF YOU SHIP THE PRODUCT TO A SERVICENTRE

Carefully pack and send prepaid, adequately insured and preferably in the original carton.
Include details of the defect claimed, and proof of date of original purchase.

Referencia rápida en español

(Spanish Quick Reference)

Conexiones básicas

Conexión a un televisor compatible con HDMI

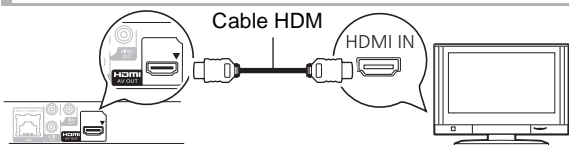

Conexión a un televisor con un cable para audio/vídeo

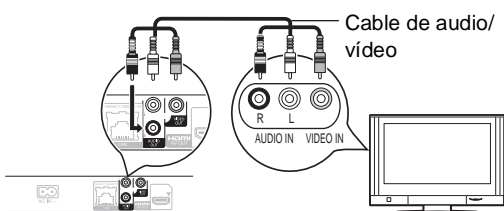

Conexión a un televisor compatible con HDMI y a un amplificador/receptor compatible con HDMI

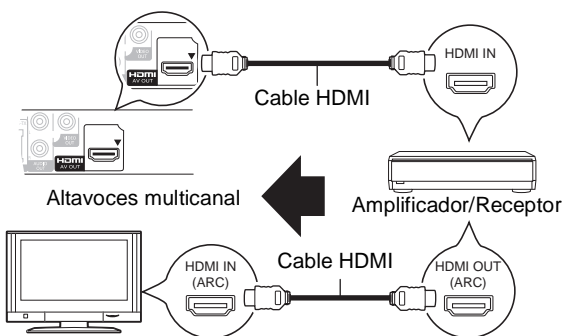

Conecte el cable de alimentación de CA por último

A una toma de corriente doméstica

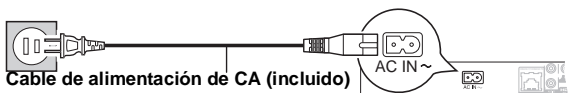

- Conéctelo cuando haya realizado el resto de conexiones.

Ahorro de energía

Esta unidad consume una pequeña cantidad de energía aunque esté ajustada en el modo de espera (Accionamiento rápido : Desactivado, aprox. 0,1 W). Para ahorrar energía cuando no vaya a utilizar la unidad durante mucho tiempo, desenchúfela de la toma de corriente.

Reproducción básica

Preparación

Encienda el televisor y seleccione la entrada de vídeo adecuada en el televisor.

- 1 Pulse [**⏻** POWER] para encender la unidad.

Después de conectar su nuevo reproductor y pulsar el botón de encendido, aparecerá la pantalla de la configuración básica.

- 2 Inserte el medio.

Inicia la reproducción

Pulse [**▶** PLAY].

Parada

Pulse [**■** STOP].

La posición de detención se memoriza.

Función de reanudación de la reproducción

Pulse [**▶** PLAY] para reiniciar la reproducción desde esta posición.

- La posición se borra si se abre la bandeja o se pulsa [**■** STOP] varias veces para visualizar "STOP" en el visor de la unidad.
- En los discos BD-Video incluidos los BD-J, la función de reanudación de la reproducción no funciona.

Pausa

Pulse [**⏸** PAUSE].

- Pulse [**⏸** PAUSE] otra vez o [**▶** PLAY] para reiniciar la reproducción.

Búsqueda/Cámara lenta

Búsqueda

Durante la reproducción, pulse [**SEARCH ◀◀**] o [**SEARCH ▶▶**].

- Música y MP3: La velocidad está fija en un paso.

Cámara lenta

Durante la pausa, pulse [**SEARCH ▶▶**].

La velocidad aumenta hasta 5 pasos.

- Pulse [**▶** PLAY] para recuperar la velocidad de reproducción normal.

Salto

Durante la reproducción o la pausa, pulse [**◀◀**] o [**▶▶**].

Salta hasta el título, capítulo o pista que desee reproducir.

- Cada pulsación aumenta el número de saltos.

Index

A Audio	Changing audio 14	N Network	24p 24
	Language 21, 22	Connection 9	
B BD-Live	16	Setting 11, 24	
D DLNA	19	Network Service	18
F File format	30	Playlists	15
Firmware update	12	Pop-up menu	14
L LAN	9	Quick Start	25
Language		Restore Default Settings	25
Audio 21, 22		Resume play function	14
Menu 22		Subtitle	21
On-screen 23		USB device	7
Soundtrack 21		VIERA Link™	
Subtitle 21, 22		“HDAVI Control™”	20





As an ENERGY STAR® Partner,* Panasonic has determined that this product meets the ENERGY STAR® guidelines for energy efficiency.

* For Canada only: The word “Participant” is used in place of the word “Partner”.

Information on Disposal in other Countries outside the European Union



This symbol is only valid in the European Union. If you wish to discard this product, please contact your local authorities or dealer and ask for the correct method of disposal.

Panasonic Consumer Electronics Company, Division of Panasonic Corporation of North America
 One Panasonic Way, Secaucus, New Jersey 07094
<http://www.panasonic.com>

Panasonic Canada Inc.
 5770 Ambler Drive
 Mississauga, Ontario
 L4W 2T3
www.panasonic.ca

